

Lemi[®]
ITALIAN WELLNESS EQUIPMENT



WATER

The WATER line includes unique up-to-date spa equipment specific for Spa treatments with water, steam bath, hydrotherapy treatments, massages, professional manicure and pedicure.

La linea WATER include delle attrezzature spa che presentano una tecnologia avanzata specifica per trattamenti Spa con acqua, bagni di vapore, trattamenti di idroterapia, massaggi, manicure e pedicure professionale.

WATER

CAPRI PEDI SPA

CAPRI PEDI SPA



COD. 142

Elegance and design, functionality and comfort. These features coexist in the perfect harmony of modern lines and elegant forms, to create a chair that enriches with charm and design and kind of environment, making the 3 simultaneously available treatments - pedicure, manicure and facial - a moment of unique relaxation and intense pleasure. Equipped with Pipeless Hydromassage, electrical movement of the seat, 180 degree rotation, backrest with gas-spring. Customizable finishes.

Eleganza, design, funzionalità e comfort. Queste caratteristiche convivono nella perfetta armonia di linee moderne e forme eleganti, per dare vita ad una poltrona che arricchisce di fascino e suggestione ogni tipologia di ambiente, trasformando i 3 trattamenti disponibili contemporaneamente pedicure, manicure e viso in un unico momento di raffinato relax. Dotata di Hydromassage Pipeless, regolazione elettrica della seduta, rotazione 180°, schienale con molla a gas. Finiture personalizzabili.

Focus on

- *AUTO-FILL function: automatic filling of the tank with level sensor*
- *Perfect for pedicure, manicure and facial treatments*
- *Pipeless Hydromassage system guaranteeing maximum hygiene and ease of cleaning*
- *180° rotation*
- *Backrest with gas-spring adjustment*
- *Entirely adjustable footrest*
- *Easy-to-clean manicure bowl*
- *Customisable padding and finishes*
- **Funzione AUTO-FILL:** riempimento automatico della vasca con sensore di livello
- **Perfetta** per trattamenti piedi, mani e viso
- **Sistema** di idromassaggio "pipeless" che garantisce la massima igiene e semplicità di pulizia
- **Movimento** elettrico della seduta
- **Rotazione** di 180°
- **Schienale** con molla a gas regolabile
- **Poggia** piedi completamente regolabile
- **Bacinelle** manicure facili da igienizzare
- **Imbottiture** e finiture personalizzabili

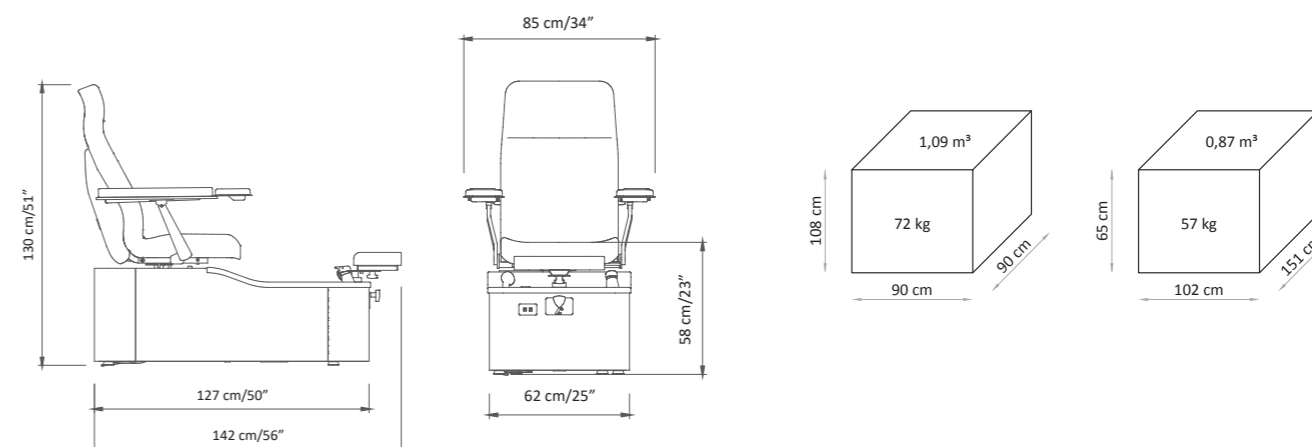

MATTRESS CUSTOMIZATION

Spa Prestige and Nefos are the exclusive upholstery lines by Lemi. The innovative material and its special finishing touch guarantee easy-cleaning and hygiene. Its extraordinary structural qualities will persist through the years. An incredibly elastic texture enhances the memory foam mattress softness and quality at its best, giving Spa Clients a complete and satisfying wellness experience.

PERSONALIZZAZIONE MATERASSO

Spa Prestige e Nefos sono le linee di rivestimento esclusive di Lemi. L'innovativo materiale e il suo speciale tocco di finitura garantiscono una facile pulizia e igiene. Le sue straordinarie qualità strutturali permangono nel corso degli anni. Una texture incredibilmente elastica migliora al massimo la morbidezza e la qualità del materasso in Memory Foam, dando ai clienti di Spa un'esperienza di benessere completa e soddisfacente.

SPA PRESTIGE COLORS

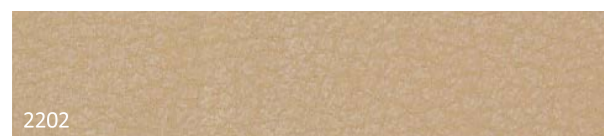
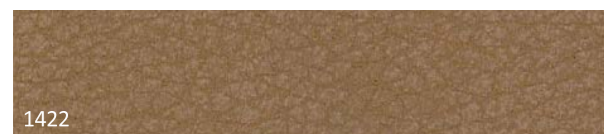
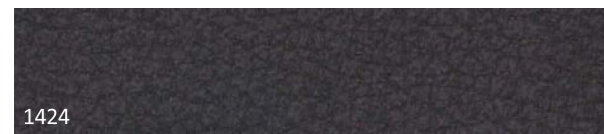

COLORI SPA PRESTIGE

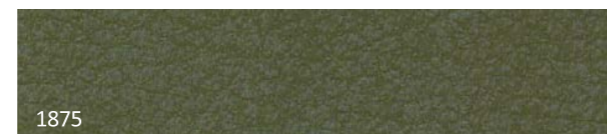
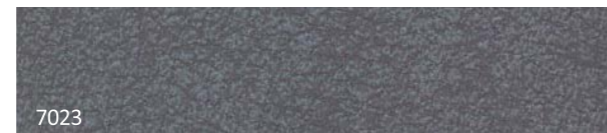
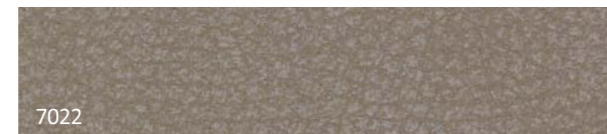

NEFOS COLORS

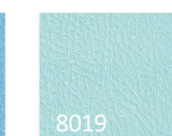
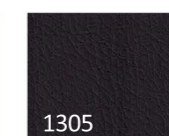
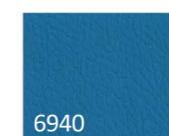
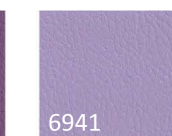
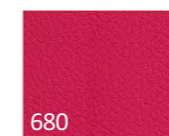
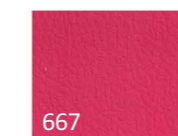
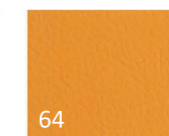
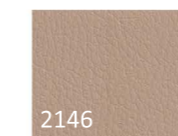
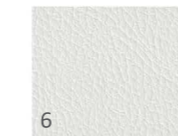

BASE CUSTOMIZATION

Today, 70% of the company's wooden equipment and treatment tables are manufactured using FSC certified lumber from unprotected forests. The woods are furnished by suppliers that have committed themselves to sustainable development, guaranteeing full compliance with the best environmental protection practices.

PERSONALIZZAZIONE BASE

Oggi, il 70% delle attrezzature e dei tavoli da trattamento in legno dell'azienda sono realizzati con legname certificato FSC proveniente da foreste non protette. I legni sprovengono da fornitori che si sono impegnati per lo sviluppo sostenibile, garantendo il pieno rispetto delle migliori pratiche di tutela ambientale.

ACCESSORIES UPON REQUEST ACCESSORI SU RICHIESTA

All Water beds have a standard setting customizable upon request.
Tutti i lettini hanno accessori standard personalizzabili su richiesta.

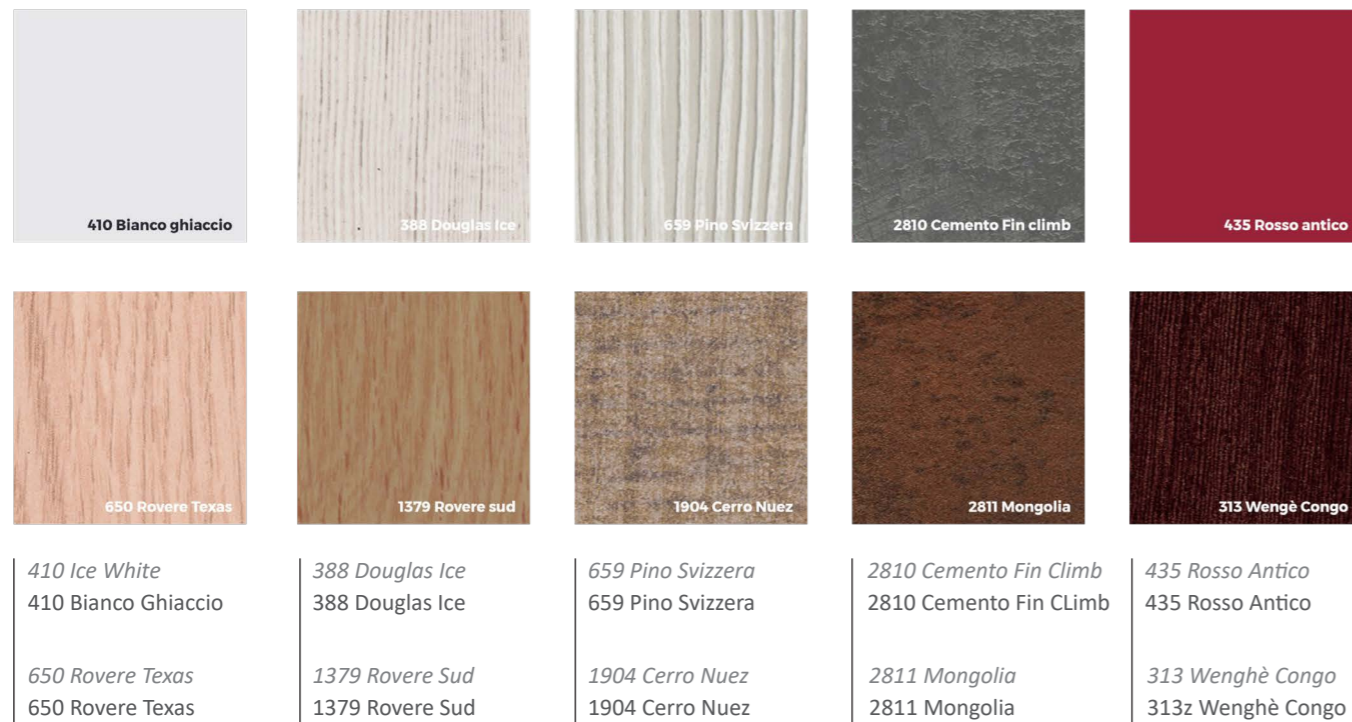

**SANI
GUEST**

Sani Guest cleaner
Detergente Sani Guest

**GO
KAL**

Go Kal cleaner
Detergente Go Kal



Customization with logo
Personalizzazione con logo

TECHNICAL REQUIREMENTS

CARATTERISTICHE TECNICHE

	voltage	frequency	absorption	warranty	garanzia
WATER LINE					
Capri Pedi Spa	230/110V ac	50/60 Hz	0,70-1,5 Amp	2 years	2 anni

REGULATIONS

All Equipment is **CE** marked

Electrical equipment and beds

Directive 2006/42/CE (Machinery Directive) and national regulations
 Directive 2004/108/CE (Electromagnetic Compatibility Directive) and national regulations.

Hydraulic equipment and beds

Directive 2006/42/CE (Machinery Directive) and national regulations

Images

The images are for illustrative purposes only and may not reflect the actual image of the product.

NORME

Tutte le attrezzature sono a marchio **CE**

Attrezzature e lettini elettrici

Direttiva 2006/42/CE (Direttiva Macchine) e disposizioni nazionali di attuazione
 Direttiva 2004/108/CE (Direttiva Compatibilità elettromagnetica) e disposizioni nazionali di attuazione.

Attrezzature e lettini idraulici

Direttiva 2006/42/CE (Direttiva Macchine) e disposizioni nazionali di attuazione

Immagini

Le immagini hanno valore puramente illustrativo e possono non rispecchiare l'immagine reale del prodotto.

Lemi[®]
 ITALIAN WELLNESS EQUIPMENT

Brusaferrri & C srl

Via Mara Maretti Soldi, 13
 26011 Casalbuttano (CREMONA) ITALY
 Phone +39-0374-363069 Fax +39-0374-363071
 info@lemigroup.it service@lemigroup.it

www.lemigroup.it